

VIVID CONTOUR 12V

Table of Contents

Specifications	2-4	Mounting Hardware	11-12
Technical Specifications	2	Standard	11
Physical Specifications	3	Plastic	11
		Spring Clip	12
Part Number Naming	4		
		Packaging	13
Connectors	5-10	Testing	13-17
Seamless	5	Photometric Data	13
Submersible Seamless	6	Certifications	14
Snap	7-8	Fixture Testing	14
Swivel	9	Charts	15-17
Barrel	10		

Technical Specifications

Light Dimension 0.35 x 0.71in (9x18mm)

Output	Red/Amber/Green/Blue/White
LED Light	Epistar SMD LED Chip
Max Run Length*	
Single Feed	24.61ft (7.5m)
Double Feed	49.21ft (15m)
Light Surface	Square profile 160°
Lumen Maintenance	70,000 Hours L70 @ 25°C : 90,000 L50 @ 25°C 50,000 Hours L70 @ 50°C : 70,000 Hours L50 @ 50°C
Electrical	
Input Voltage	12V DC
Power Consumption	1.37W/ft (4.5W/m)
Physical	
LED Count	22 LEDs / ft (72 LEDs/m)
LED Spacing	0.55in (13.89mm)
Cutting Unit Length	1.64in (41.7mm) (3 LEDs)
Thermal Management	Free air convection
Fixture Connections	End, side & bottom lead wires
Minimum Bend Diameter	3.54in (90mm) (Side Bending Only)
Temperature Ranges	
Installation	32°F to 140°F (0°C to 60°C)
Operating	-13°F to 140°F (-25°C to 60°C)
Humidity	0-95% non condensing
Dependability	
Warranty	5 Year Warranty
Safety	
Certification	Tested to UL & CSA by Underwriters Laboratory for use in USA and Canada, complies with California Title 24 Requirements, Lighting Facts. Exceeds ANSI C78.377A, CE & RoHS Compliant.
IP Rating	IP68 with appropriately rated accessories

*Max Run Length: Unless otherwise stated, snap and seamless run lengths are the same.

Technical Specifications

Available Colors

Color	CCT Wavelength
Red	620-630nm
Green	520-530nm
Blue	465-475nm
Amber	585-595nm
2200K	2238 ± 102K
2500K	2460 ± 120K
2700K (WW)	2725 ± 145K
3000K	3045 ± 175K
3500K (W)	3465 ± 245K
4000K	3985 ± 275K
4500K (CW)	4503 ± 243K
5000K	5029 ± 283K
5700K (DW)	5669 ± 355K

Lumen Count

Color	Per Foot	Per Meter	Power
Red	>13.72lm	>45lm	1.37W/ft (4.5W/m)
Green	>24.38lm	>80lm	1.37W/ft (4.5W/m)
Blue	>4.57lm	>15lm	1.37W/ft (4.5W/m)
Amber	>15.24lm	>50lm	1.37W/ft (4.5W/m)
2200K	>33.53lm	>110lm	1.37W/ft (4.5W/m)
2500K	>33.53lm	>110lm	1.37W/ft (4.5W/m)
2700K (WW)	>33.53lm	>110lm	1.37W/ft (4.5W/m)
3000K	>36.58lm	>120lm	1.37W/ft (4.5W/m)
3500K (W)	>36.58lm	>120lm	1.37W/ft (4.5W/m)
4000K	>36.58lm	>120lm	1.37W/ft (4.5W/m)
4500K (CW)	>36.58lm	>120lm	1.37W/ft (4.5W/m)
5000K	>36.58lm	>120lm	1.37W/ft (4.5W/m)
5700K (DW)	>33.53lm	>110lm	1.37W/ft (4.5W/m)

*Color Jackets:

For standard or custom color jacket options, contact your Account Manager. Minimum order quantity of 656ft (200m).
 CCT: 2500K, 4500K, 5000K. Please contact your Account Manager. Minimum order quantity of 656ft (200m)

CRI90

Available Colors

Color	CCT
2200K	2238 ± 102K
2500K	2460 ± 120K
2700K (WW)	2725 ± 145K
3000K	3045 ± 175K
3500K (W)	3465 ± 245K
4000K	3985 ± 275K
4500K (CW)	4503 ± 243K
5000K	5029 ± 283K

Lumen Count

Color	Per Foot	Per Meter	Power
2200K	>27.43lm	>90lm	3.66W/ft (12W/m)
2500K	>27.43lm	>90lm	3.66W/ft (12W/m)
2700K (WW)	>27.43lm	>90lm	3.66W/ft (12W/m)
3000K	>27.43lm	>90lm	3.66W/ft (12W/m)
3500K (W)	>30.48lm	>100lm	3.66W/ft (12W/m)
4000K	>30.48lm	>100lm	3.66W/ft (12W/m)
4500K (CW)	>30.48lm	>100lm	3.66W/ft (12W/m)
5000K	>30.48lm	>100lm	3.66W/ft (12W/m)

For 2200K, 2500K, 4500K, 5000K: Minimum order quantity of 100 meters.

Physical Specifications



Light Profile

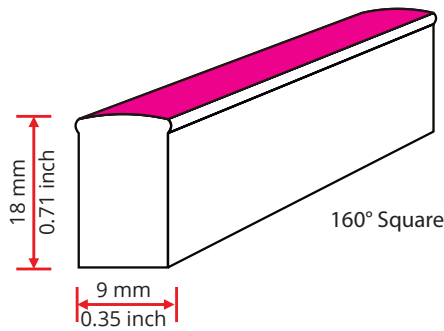

Bending Direction

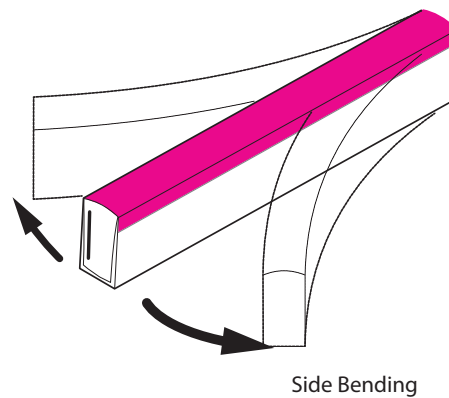

Minimum Bending Diameter

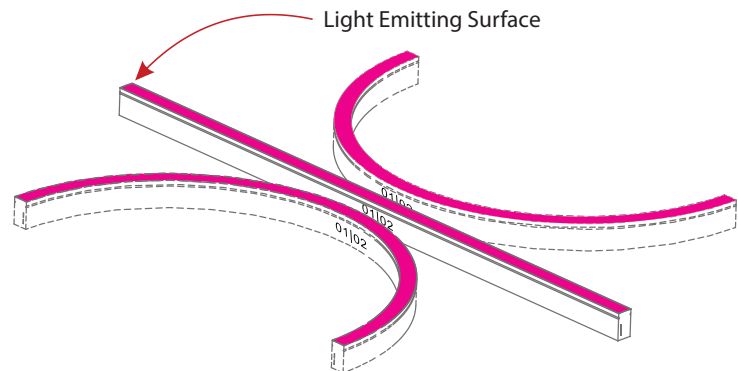
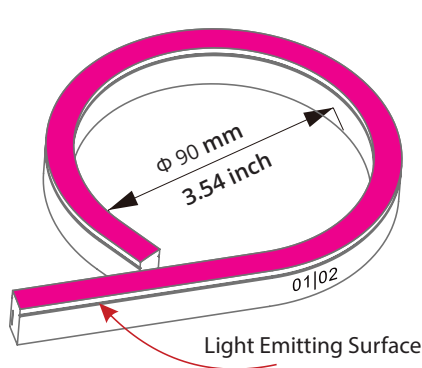

Part Number Naming Convention

NF-09A-1-01-2W-X-XXX-12DC



For full part number naming rules, please refer to the document on www.glls.com/support/documentation/

Connectors

Seamless Connectors

IP67: Rated for wet locations, not submersion.
Factory Assembly only.

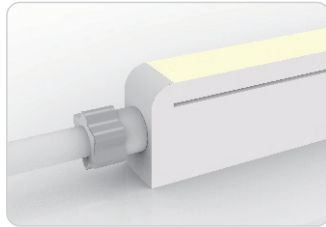

Seamless End Exit

NA-09A-1-01-2W-SE-0-EN-XXX-P

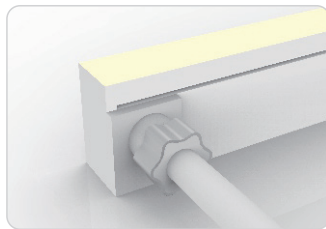
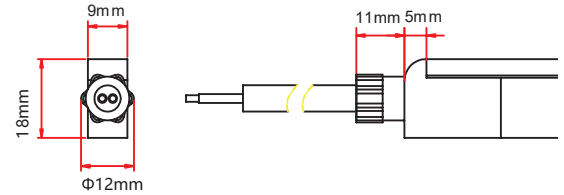

Seamless Side Exit

NA-09A-1-01-2W-SE-1-SR-XXX-P
NA-09A-1-01-2W-SE-2-SL-XXX-P

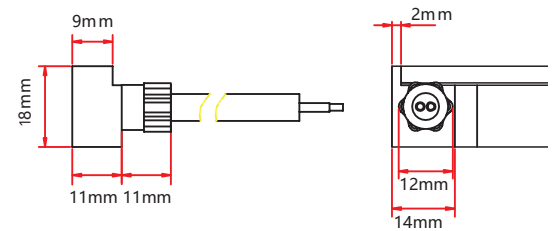

Seamless Bottom Exit

NA-09A-1-01-2W-SE-0-BO-XXX-P

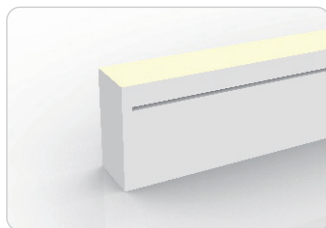
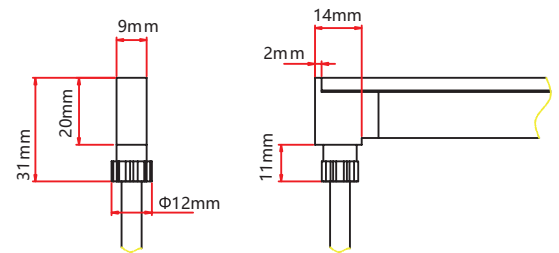

Seamless End Cap

NA-09A-1-01-0W-SE-1-EC-000-P
NA-09A-1-01-0W-SE-2-EC-000-P

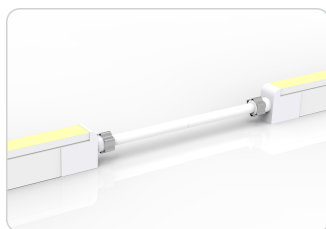
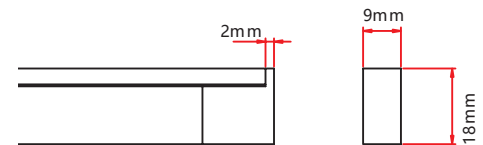

Seamless Jumper

NA-09A-1-01-2W-SE-0-EJ-XXX-P

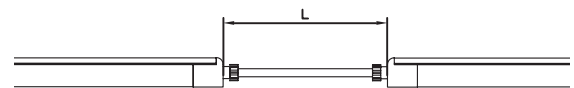

Connectors

IP68: Submersible. Waiting on 3rd party certification from UL as of 18/04/12. Factory Assembly only.

Submersible Seamless Connectors

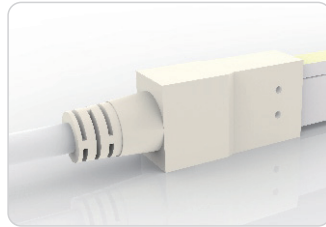

Submersible End Exit
NA-09A-1-01-2W-SU-0-EN-XXX-P

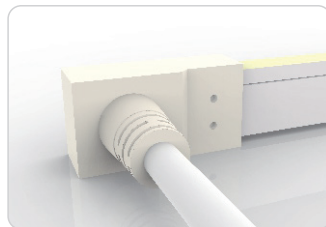
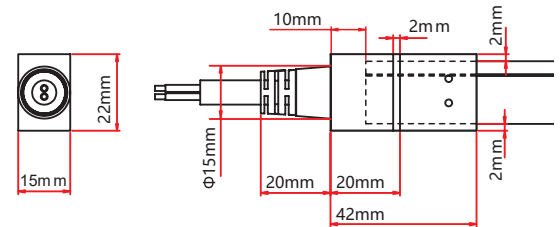

Submersible Side Exit
NA-09A-1-01-2W-SU-1-SR-XXX-P
NA-09A-1-01-2W-SU-2-SL-XXX-P

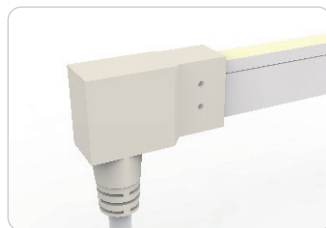
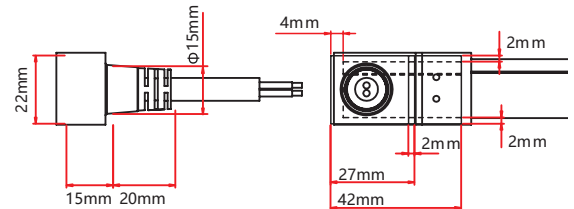

Submersible Bottom Exit
NA-09A-1-01-2W-SU-0-BO-XXX-P

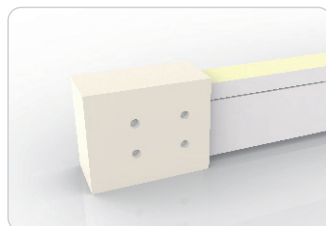
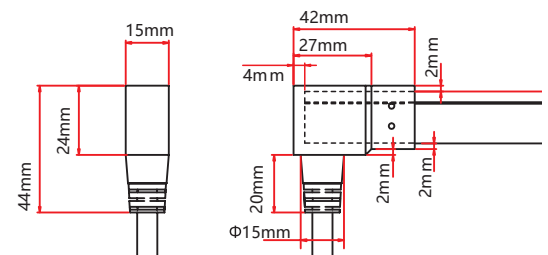

Submersible End Cap
NA-09A-1-01-0W-SU-1-EC-000-P
NA-09A-1-01-0W-SU-2-EC-000-P

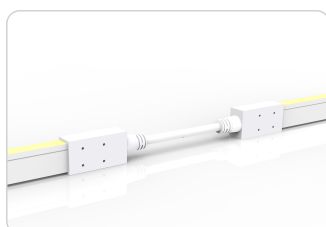
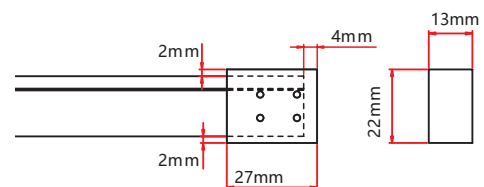

Submersible Jumper
NA-09A-1-01-2W-SU-0-EJ-XXX-P

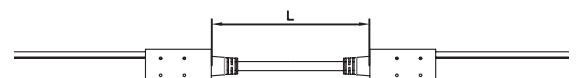

Connectors

Snap Connectors

IP67: Rated for outdoor use.
Factory Assembly or DIY.

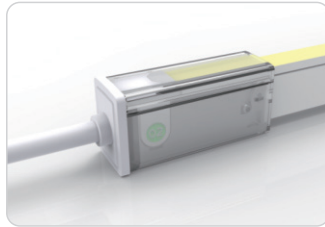

Snap End Exit

NA-09A-1-01-2W-SC-1-EN-XXX-P
NA-09A-1-01-2W-SC-2-EN-XXX-P

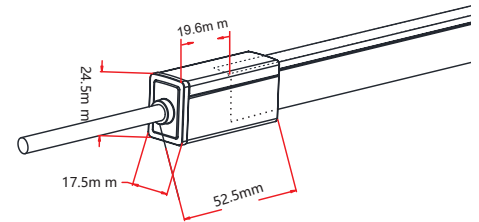

Snap Side Exit

NA-09A-1-01-2W-SC-1-SL-XXX-P
NA-09A-1-01-2W-SC-2-SL-XXX-P
NA-09A-1-01-2W-SC-1-SR-XXX-P
NA-09A-1-01-2W-SC-2-SR-XXX-P

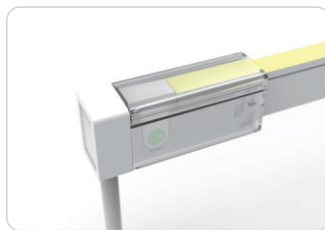
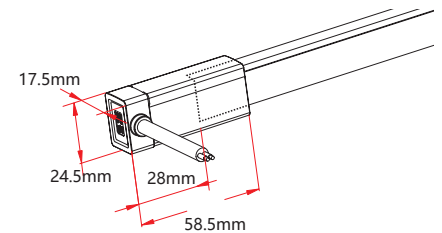

Snap Bottom Exit

NA-09A-1-01-2W-SC-1-BO-XXX-P
NA-09A-1-01-2W-SC-2-BO-XXX-P

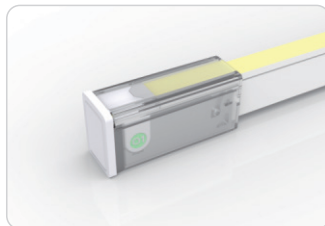
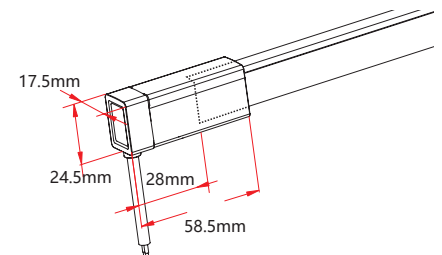

Snap End Cap

NA-09A-1-01-2W-SC-1-EC
NA-09A-1-01-2W-SC-2-EC

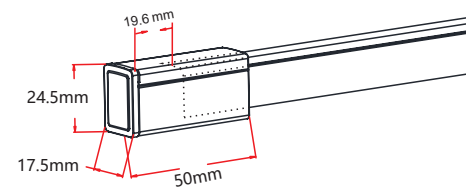

Connectors

IP67: Rated for outdoor use.
Factory Assembly or DIY.

Snap Connectors

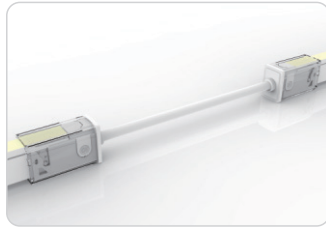

Snap Jumper

NA-09A-1-01-2W-SC-0-EJ-XXX-P

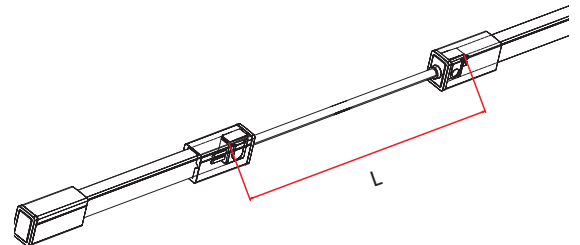

Snap Power T Feed

NA-09A-1-01-2W-SC-0-TF-XXX-P

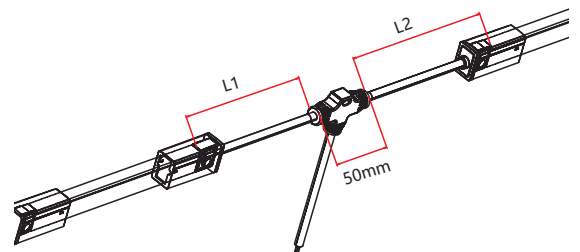

Connectors

Swivel Connectors

IP20: Rated for indoor use only.
Factory Assembly or DIY.

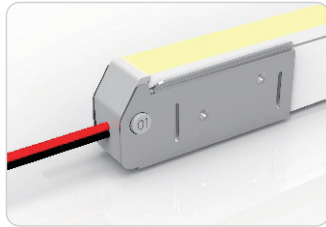

Swivel End Exit

NA-09A-1-01-2W-SV-1-EN-XXX-P
NA-09A-1-01-2W-SV-2-EN-XXX-P

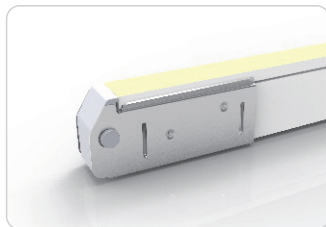
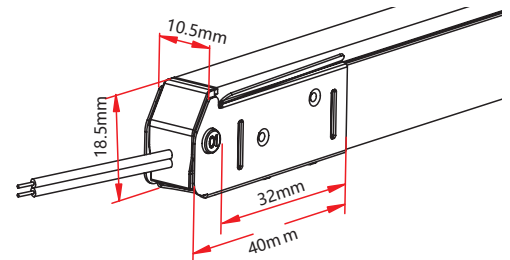

Swivel End Cap

NA-09A-1-01-0W-SV-1-EC-000-P
NA-09A-1-01-0W-SV-2-EC-000-P

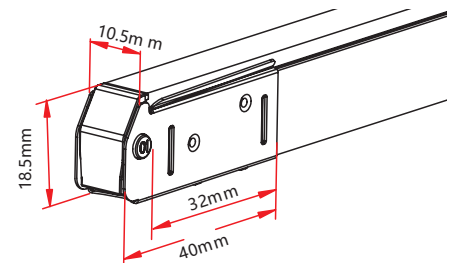

Connectors

IP20: Rated for indoor use only.
Factory Assembly only.

Barrel Connectors



Barrel Connectors

- NA-XX-BC-DC-CXX-F
- NA-XX-BC-DC-CXX-M
- NA-XX-BN-XXA-CXX-F
- NA-XX-BN-XXA-CXX-M
- NA-XX-PL-XXA-CXX-F
- NA-XX-PL-XXA-CXX-M

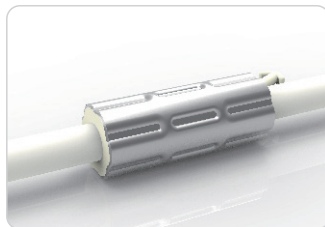
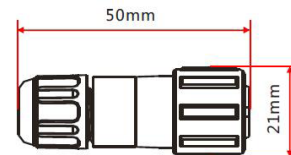

Anti-Wicking Ferrule

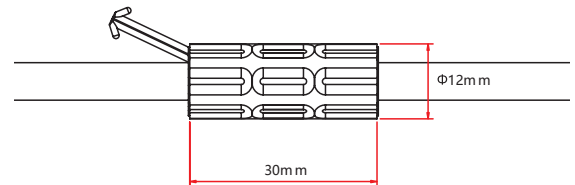

Anvil Cutter

Optional accessory for on-site cutting.

Factory order only

Mounting Hardware

Standard Anodized Aluminum Channel

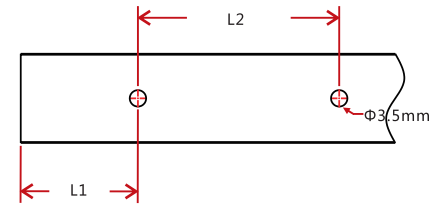
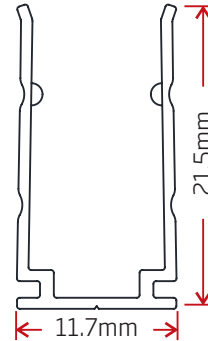
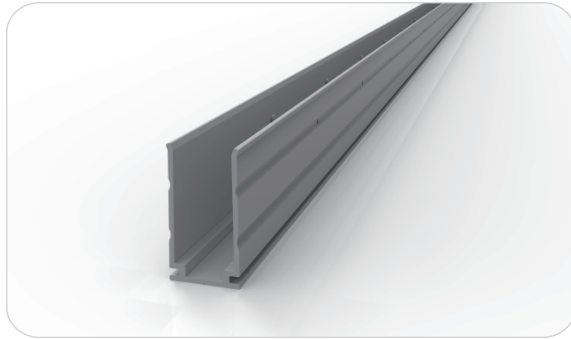

W x H	Standard Length	Part Number	L1	L2	Screw Hole Φ	Hole #
0.43 x 0.87in (11x22mm)	1.38in (35mm)	CL-09-R-AL-3C5-SD	0.69in (17.5mm)	/	Φ 0.14in (3.5mm)	1
	19.69in (500mm)	CH-09-R-AL-0M5-SD	0.98in (25mm)	/	Φ 0.14in (3.5mm)	3
	39.37in (1000mm)	CH-09-R-AL-01M-SD	3.94in (100mm)	7.87in (200mm)	Φ 0.14in (3.5mm)	5
	78.74in (2000mm)	CH-09-R-AL-02M-SD	3.94in (100mm)	7.87in (200mm)	Φ 0.14in (3.5mm)	10

Plastic Channel

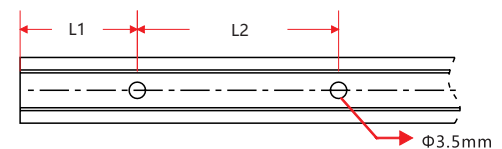
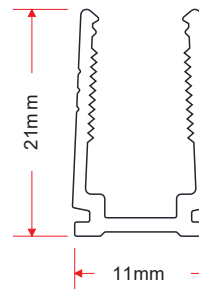

W x H	Standard Length	Part Number	L1	L2	Screw Hole Φ	Hole #
0.43 x 0.83in (11x21mm)	19.69in (500mm)	CH-09-R-PL-0M5-SD	1.97in (50mm)	7.87in (200mm)	Φ 0.14in (3.5mm)	3
	39.37in (1000mm)	CH-09-R-PL-01M-SD	3.94in (100mm)	7.87in (200mm)	Φ 0.14in (3.5mm)	5
	78.74in (2000mm)	CH-09-R-PL-02M-SD	3.94in (100mm)	7.87in (200mm)	Φ 0.14in (3.5mm)	10

Mounting Hardware

Spring Clip Anodized Aluminum Channel

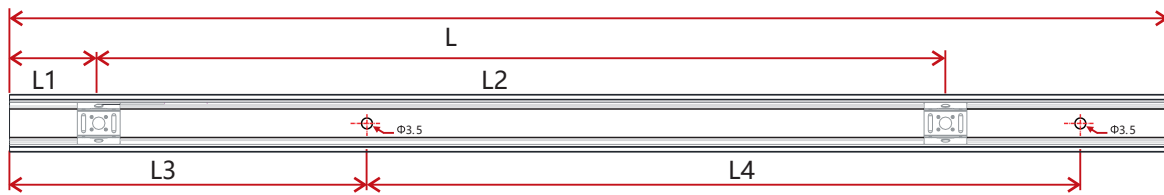
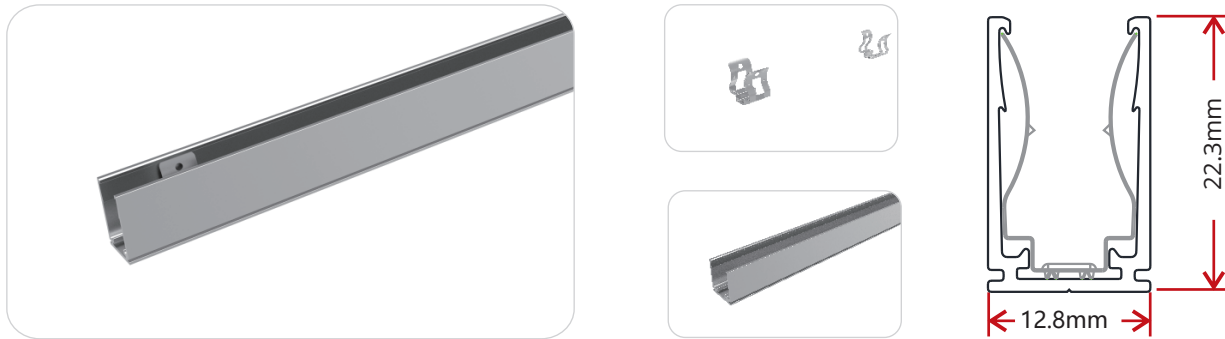

W x H	Standard Length	Part Number	L1	L2	L3	L4	Screw Hole Φ	Hole #	Clip #
0.49 x 0.88in (12.8x22.3mm)	1.38in (35mm)	CL-09-R-AL-3C5-SP	0.69in (17.5mm)	/	0.2in (5mm)	0.98in (25mm)	Φ 0.14in (3.5mm)	2	1
	19.69in (500mm)	CH-09-R-AL-0M5-SP	0.98in (25mm)	8.86in (225mm)	1.97in (50mm)	7.87in (200mm)	Φ 0.14in (3.5mm)	3	3
	39.37in (1000mm)	CH-09-R-AL-01M-SP	0.98in (25mm)	9.35in (237.5mm)	3.94in (100mm)	7.87in (200mm)	Φ 0.14in (3.5mm)	5	5
	78.74in (2000mm)	CH-09-R-AL-02M-SP	0.98in (25mm)	9.6in (243.8mm)	3.94in (100mm)	7.87in (200mm)	Φ 0.14in (3.5mm)	10	9

Packaging



White Box

Packing Box

Fixture Length	White Box Dimensions	Packing Box Dimensions	# Of White Boxes	Package Weight
196.85in (5m)	13.78x1.65x18.11in (35x4.2x46cm)	18.9x14.57x9.45in (48x37x24cm)	5	14.33lbs (6.5kg)
393.7in (10m)	17.72x1.65x22.05in (45x4.2x56cm)	22.83x18.5x9.45in (58x47x24cm)	5	26.46lbs (12kg)
590.55in (15m)	20.08x2.05x24.41in (51x5.2x62cm)	25.2x20.87x11.02in (64x53x28cm)	5	37.48lbs (17kg)
590.55in (15m)	20.08x2.05x24.41in (51x5.2x62cm)	25.2x20.87x6.89in (64x53x17.5cm)	3	26.46lbs (12kg)
787.4in (20m)	24.21x1.65x28.35in (61.5x4.2x72cm)	29.13x25x4.13in (74x63.5x10.5cm)	2	22.05lbs (10kg)
1181.1in (30m)	26.77x2.05x31.10in (68x5.2x79cm)	31.89x29.56x4.92in (81x70x12.5)	2	30.86lbs (14kg)

Testing

Photometric Data

	Red/Amber		Green/Blue/White			White (CRI90)	
LED Type	SMD		SMD			SMD	
Beam Angle	160°		160°			160°	
Color	Wavelength	Lumen/m	Color	CCT	Lumen/m	CCT	Lumen/m
Red	620-630nm	>45lm	2500K	2460±120K	>110lm	2460±120K	>90lm
Green	520-530nm	>80lm	2700K	2725±145K	>110lm	2725±145K	>90lm
Blue	465-475nm	>15lm	3000K	3045±175K	>120lm	3045±175K	>90lm
Amber	585-595nm	>50lm	3500K	3465±245K	>120lm	3465±245K	>100lm
			4000K	3985±275K	>120lm	3985±275K	>100lm
			4500K	4503±243K	>120lm	4503±243K	>100lm
			5000K	5029±283K	>120lm	5028±283K	>100lm
			5700K	5669±355K	>110lm		
			6500K	6532±510K	>110lm		

Testing

Certifications

	Testing Organization	Certificate Serial N°	Report Reference
UL 2108	UL	20160726-E360029	E360029-2013
CE-EMC	SGS	SZEM1702001259LMV	SZEM160600421302

Fixture Testing

Optical Testing

Spectrum Analysis	IES LM 79 (Lumen, CCT, CRI, XY, SDCM, wavelength)
Photometric Distribution	IES LM 73 (Lumen intensity distribution & Lux diagram)
Lumen Maintenance & Lifetime	IES LM 84 & IES TM28

Temperature Testing

Normal Temperature Test	UL1598 & UL2388 & IEC60598-1 & IEC60598-2-21
Abnormal Operation Test	UL1598 & UL2388 & IEC60598-1 & IEC60598-2-21

Durability Testing

Bending Test	Manufacturer-defined, 500 cycles
Swing Test	UL2388, >750 cycles
Tensile Test	Manufacturer-defined, > the weight of light in max. connection length double feed
Twist Test	Max connection length double feed Manufacturer-defined, >200 cycles
Ball Impact	UL1598 & UL2388 & IEC60598-1 & IEC60598-2-21
IK07 IK08	IEC62262

Environmental Testing

Chlorinated Water Immersion	BG9667, PH6.8-7.6, free chlorine 0.3-0.6mg/L
Salt Water Immersion	IEC60598-1, Salinity 4%
Salt Spray Test	IEC68-2-11
Outdoor Exposure	Manufacturer-defined
Flame Resistance	UL94
UV Exposure	ASTMG 154, ISO 4892-3, UVA @ 340nm
IPX5, IPX6, IPX7, IPX8	IEC60529
Temperature Shock	Manufacturer-defined, -40°C - 60°C (typical temperature range)
Constant Temperature	Manufacturer-defined

Testing Charts

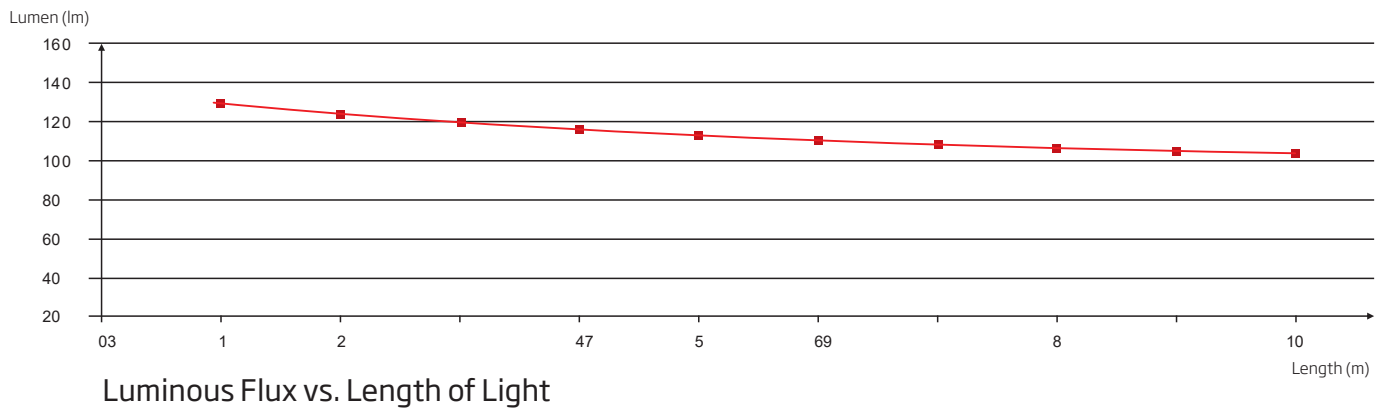
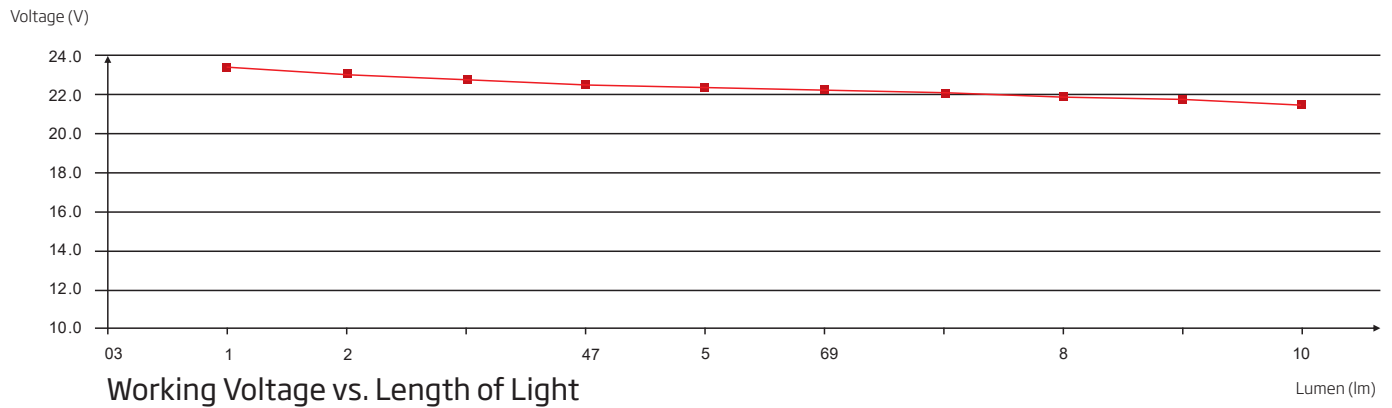
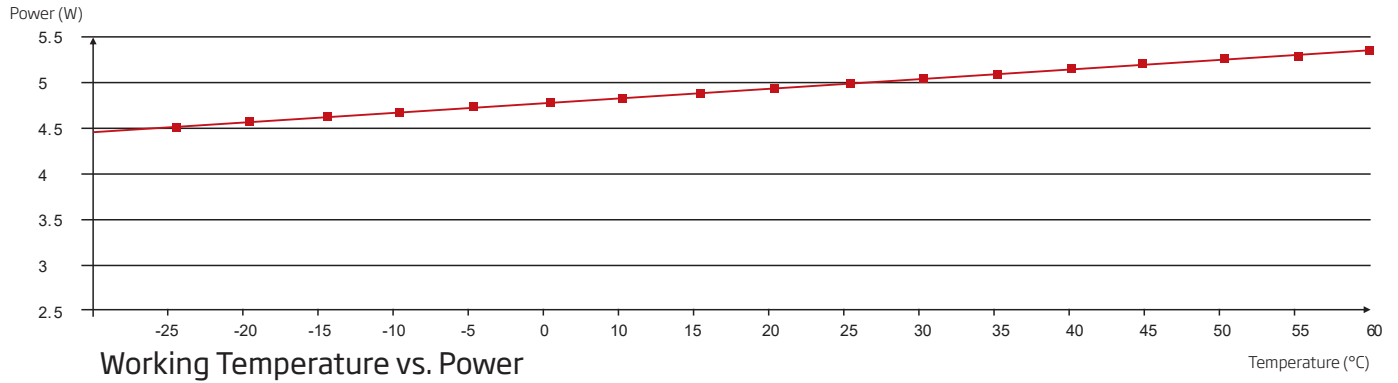

Testing

Charts

ANSI STANDARD

Nominal CCT Categories

Nominal CCT	Target CCT and tolerance(K)	Target D_{uv}	D_{uv} Tolerance Range
2200K	2238 ±102	0.0000	Tx:CCT of the source
2500K	2460±120	0.0000	For Tx<2870K
2700K	2725 ±145	0.0000	0.000±0.0060
3000K	3045±175	0.0001	For Tx≥2870K
3500K	3465±245	0.0005	$D_{uv}(Tx)±0.0060$
4000K	3985±275	0.0010	where
4500K	4503±243	0.0015	$D_{uv}(Tx)=57700 \times (1/Tx)^2$
5000K	5029±283	0.0020	-44.6 × (1/Tx)
5700K	5667±355	0.0025	+0.00854
6500K	6532±510	0.0031	

Flexible CCT $T_F^{3)} ± \Delta T^{2)}$ $D_{uv} T_F^{3)}$
(2200-6500K)

Remark:

- 1) T_F is chosen to be at 100K steps (2300,2400,.....,6400K),excluding the ten nominal CCTs listed in Table 1.
- 2) $\Delta T = 1.1900 \times 10^8 \times T^{-3} - 1.5434 \times 10^4 \times T^2 + 0.7168 \times T - 902.55$
- 3) Same as in the D_{uv} Tolerance Range.

(X,Y) Chromaticity Diagram

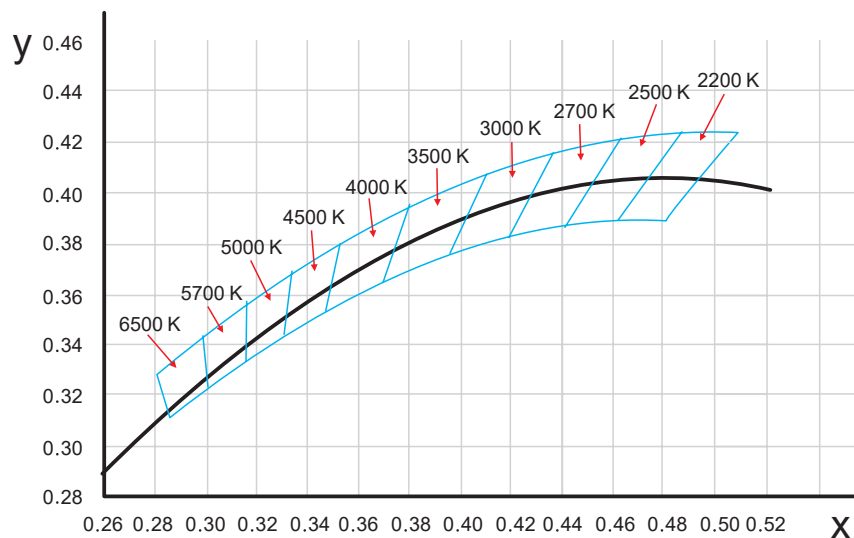

Testing

Charts

Wavelength of Color Light

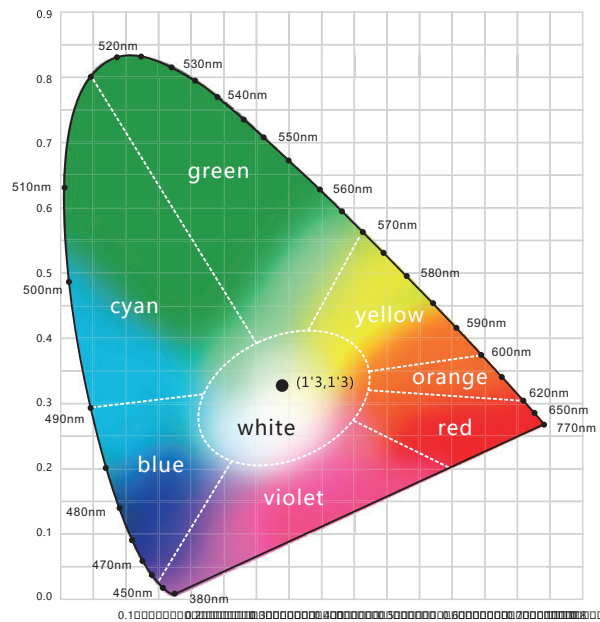

Light Color

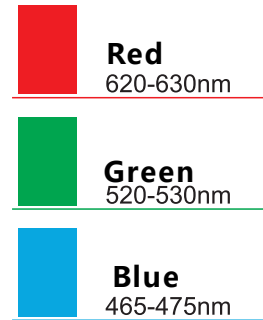

Loading Chart

Rated Power	Power Supply					Power Supply				
	35W	60W	75W	80W	75W	80W	100W	120W	150W	185W
1.37W/ft (4.5W/m)	19.69ft (6m)	24.61ft (7.5m)	/	/	42.65ft (13m)	45.93ft (14m)	49.21ft (15m)	/	/	/
Lead Type	Single Feed				Double Feed					
	DC input				DC input		DC input			
	01/02				01		02			

Note: These are the max recommended run lengths based on power supply

For example: It is recommended to use one 60W power supply for a single-fed run of 24.61ft (7.5m) at 1.37W/ft (4.5W/m).